

Scaled data based on original data using  
LM-79-2019 Approved Method: Electrical and Photometric Measurements of Solid-State  
Lighting Products

Test Report Prepared for

Cooper Lighting Solutions

Brand: CORELITE

Report Number: P1215786

Luminaire Tested: 24-ID2-35-CFD1-L835-U

Issue Date: 12/5/2025

**Test Information**

Test Method: LM-79-2019  
Report Number: P1215786  
TEST IS SCALED FROM IESNA LM-79-08 TEST DATA (G3-2508-510-8)  
Test Lab: INNOVATION CENTER  
Issue Date: 12/5/2025  
Manufacturer: COOPER LIGHTING SOLUTIONS  
Product Line: CORELITE  
Catalog Number: 24-ID2-35-CFD1-L835-U  
Description: 2X4 IN DEPTH TROFFER WITH 1INCH CUBE DROP LENS  
Light Source: 3500K CCT, 80 CRI LEDS  
Ballast/Driver: ELECTRONIC DRIVER

**Summary**

Lumens per Lamp: N/A  
Luminaire Lumens: 3756.3 lumens  
Efficiency: N/A  
Efficacy: 123.6 lumens/watt  
Spacing Criteria (0/90/45): 1.2 / 1.2 / 1.31  
Luminous Opening: Rectangular w/ Sides (W: 2' x L: 4' x H: 0.08')  
CIE Type: Direct  
  
Input Watts (W): 30.4  
Input Voltage (V): 120  
Input Current (Ain): NR  
Voltage Rise (V): NR  
Power Factor: NR  
Total Harmonic Distortion (THDi): NR  
Frequency (hertz): 60  
Stabilization Time: NR  
Operation Time: NR  
Ambient Temperature (°C): NR  
Test Distance: 24 FT

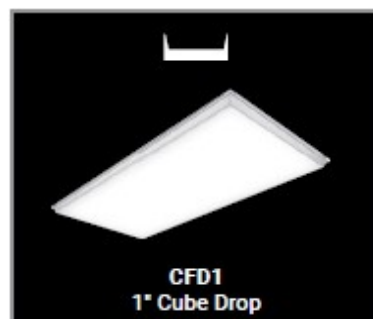

TEST NUMBER: P1215786  
CATALOG NUMBER: 24-ID2-35-CFD1-L835-U

### Luminous Intensity Polar Plot

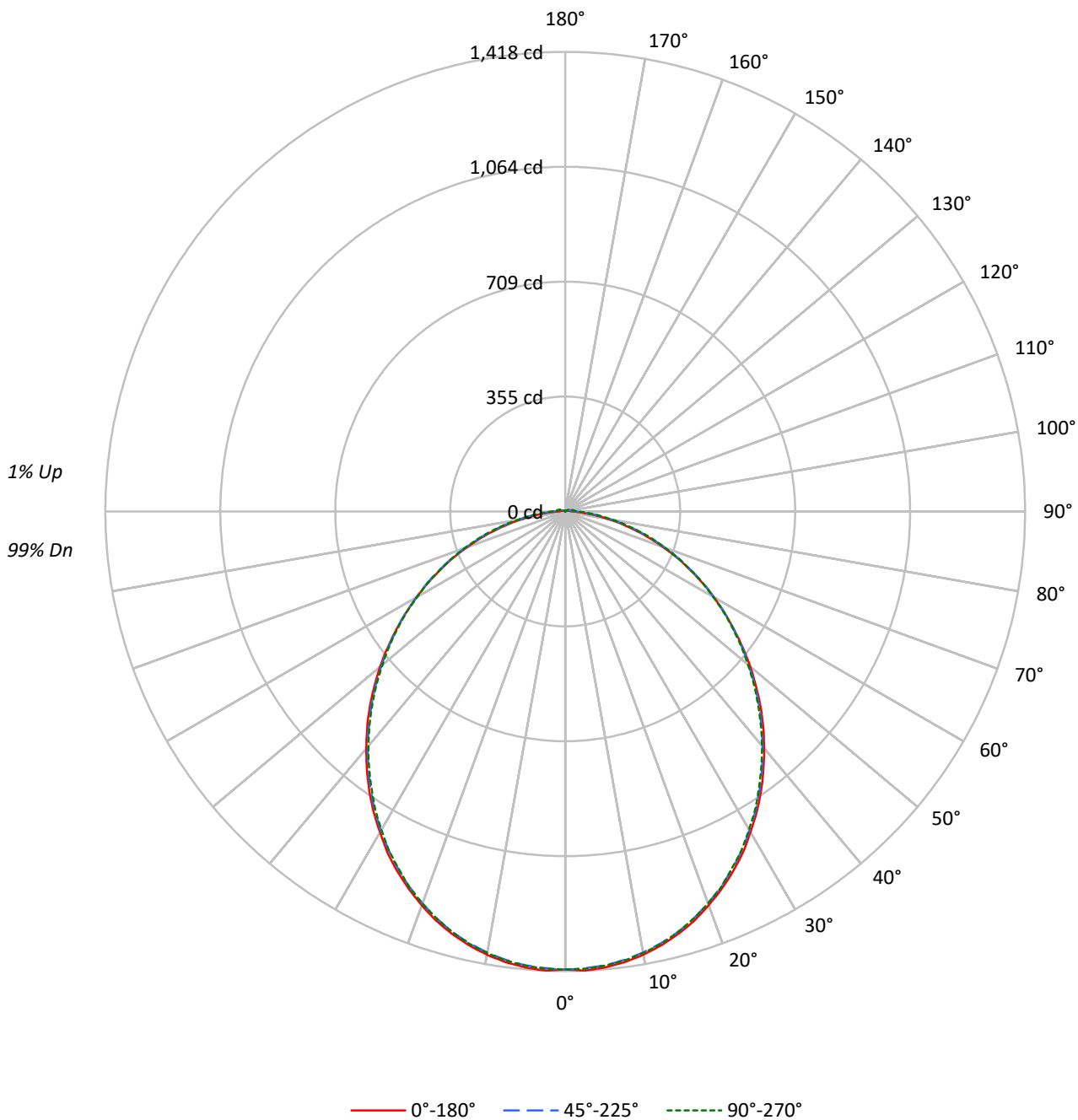



TEST NUMBER: P1215786  
 CATALOG NUMBER: 24-ID2-35-CFD1-L835-U

**COEFFICIENT OF UTILIZATION - ZONAL CAVITY METHOD:**

RF	20				20				20				20				20	
RC	80				70				50				30				10	0
RW	70	50	30	10	70	50	30	10	50	30	10	50	30	10	50	30	10	0
RCR																		
0	119	119	119	119	116	116	116	116	110	110	110	105	105	105	101	101	101	99
1	108	104	99	96	106	101	97	94	97	94	91	93	90	88	89	87	85	83
2	99	91	84	78	96	89	82	77	85	80	75	81	77	73	78	74	71	69
3	90	80	72	65	88	78	71	65	75	68	63	72	66	62	69	65	61	58
4	83	71	62	55	80	69	61	55	67	60	54	64	58	53	62	57	52	50
5	76	63	54	48	74	62	54	48	60	53	47	58	51	46	56	50	46	44
6	70	57	48	42	68	56	48	42	54	47	41	52	46	41	51	45	40	38
7	65	52	43	37	64	51	43	37	49	42	37	48	41	36	46	40	36	34
8	61	47	39	33	59	47	39	33	45	38	33	44	37	33	43	37	32	30
9	57	44	35	30	55	43	35	30	42	35	30	41	34	29	39	34	29	27
10	53	40	32	27	52	40	32	27	39	32	27	38	31	27	37	31	27	25

**AVERAGE LUMINANCE (cd/sqm):**

	0°	45°	90°
0°	1901	1901	1901
5°	1904	1891	1893
10°	1891	1874	1877
15°	1869	1851	1852
20°	1838	1815	1816
25°	1802	1772	1771
30°	1754	1724	1721
35°	1706	1669	1664
40°	1648	1606	1604
45°	1589	1543	1538
50°	1524	1473	1470
55°	1450	1402	1402
60°	1378	1326	1325
65°	1292	1247	1250
70°	1197	1160	1165
75°	1078	1037	1061
80°	928	903	939
85°	758	776	861

**MAXIMUM LUMINANCE 45°-90°:**

Horizontal Angle: 0°  
 Vertical Angle: 45°  
 Luminance: 1589 cd/sqm



TEST NUMBER: P1215786  
 CATALOG NUMBER: 24-ID2-35-CFD1-L835-U

**ZONAL LUMENS:**

Zone	Lumens	% Fixture
0°-10°	133.5	3.6
10°-20°	378.7	10.1
20°-30°	561.1	14.9
30°-40°	654.3	17.4
40°-50°	652.2	17.4
50°-60°	567.7	15.1
60°-70°	423.2	11.3
70°-80°	245.6	6.5
80°-90°	85.6	2.3
90°-100°	25.7	0.7
100°-110°	15.4	0.4
110°-120°	8.2	0.2
120°-130°	3.5	0.1
130°-140°	1.0	0.0
140°-150°	0.3	0.0
150°-160°	0.2	0.0
160°-170°	0.0	0.0
170°-180°	0.0	0.0
0°-30°	1073.4	28.6
0°-40°	1727.7	46.0
0°-60°	2947.6	78.5
0°-90°	3702.0	98.6
90°-120°	49.2	1.3
90°-150°	54.1	1.4
90°-180°	54.0	1.4
0°-180°	3756.3	100.0

**CANDELA DISTRIBUTION:**

	0°	22.5°	45°	67.5°	90°	Flux
0°	1413	1413	1413	1413	1413	
5°	1412	1408	1406	1404	1407	134
15°	1349	1345	1344	1341	1344	380
25°	1225	1222	1217	1216	1215	564
35°	1053	1050	1046	1043	1042	658
45°	852	848	845	842	841	657
55°	636	637	634	634	632	569
65°	423	426	427	428	426	420
75°	223	227	231	237	235	237
85°	60	68	75	79	81	65
90°	20	26	33	38	39	13
95°	15	18	24	27	28	12
105°	10	10	15	18	19	11
115°	6	5	8	10	12	6
125°	4	3	3	5	7	3
135°	2	1	0	2	2	1
145°	0	0	0	0	0	0
155°	0	0	0	0	0	0
165°	0	0	0	0	0	0
175°	0	0	0	0	0	0
180°	0	0	0	0	0	0



TEST NUMBER: P1215786  
 CATALOG NUMBER: 24-ID2-35-CFD1-L835-U

**CANDELA DISTRIBUTION (FULL):**

	0°	22.5°	45°	67.5°	90°
0°	1413.2	1413.2	1413.2	1413.2	1413.2
2.5°	1417.8	1413.7	1410.6	1409.6	1412.2
5°	1412.2	1407.6	1405.5	1404.0	1406.6
7.5°	1402.5	1398.9	1395.8	1394.3	1397.4
10°	1388.7	1384.1	1382.0	1380.5	1383.6
12.5°	1370.8	1366.7	1364.6	1363.1	1366.2
15°	1349.3	1344.7	1343.7	1340.6	1343.7
17.5°	1323.8	1319.7	1316.6	1315.6	1317.1
20°	1293.1	1290.5	1287.0	1285.9	1287.0
22.5°	1260.4	1257.3	1254.2	1252.2	1255.3
25°	1225.1	1221.5	1217.4	1215.9	1215.4
27.5°	1186.8	1182.2	1179.1	1176.0	1178.1
30°	1142.3	1140.3	1136.7	1134.6	1133.6
32.5°	1099.4	1097.8	1093.3	1089.2	1090.2
35°	1052.9	1049.8	1046.2	1042.7	1041.6
37.5°	1004.3	1001.3	997.2	994.1	993.6
40°	954.2	952.2	947.1	944.0	944.0
42.5°	904.1	901.6	896.0	894.4	892.9
45°	852.0	848.4	845.4	842.3	840.8
47.5°	797.8	795.8	792.2	790.2	789.1
50°	745.2	742.6	739.1	737.5	735.5
52.5°	690.0	690.0	687.4	685.9	683.9
55°	635.8	637.3	633.8	634.3	631.7
57.5°	582.1	583.7	584.2	580.6	580.1
60°	530.0	530.5	529.0	529.0	526.4
62.5°	476.3	477.9	480.4	478.9	478.4
65°	423.2	425.7	427.3	428.3	426.3
67.5°	373.6	376.2	378.7	377.7	377.2
70°	321.0	324.0	329.2	331.2	328.6
72.5°	271.9	276.0	278.6	281.6	282.6
75°	222.8	227.4	231.0	236.6	234.6
77.5°	176.8	182.5	187.1	191.7	191.7
80°	133.4	139.0	144.6	149.8	148.7
82.5°	94.0	100.7	106.3	111.9	113.0
85°	60.3	67.5	74.6	79.2	81.3
87.5°	36.3	41.9	49.6	54.7	56.7
90°	20.4	26.1	33.2	38.3	39.4
92.5°	16.9	20.4	26.6	31.2	31.7
95°	15.3	18.4	24.0	27.1	28.1
97.5°	13.8	15.8	21.5	25.0	26.1
100°	12.8	13.8	18.9	22.5	23.5
102.5°	11.2	12.3	16.9	19.9	21.5
105°	10.2	10.2	14.8	17.9	19.4
107.5°	9.2	8.7	12.8	15.8	17.4
110°	8.2	7.2	11.2	13.8	15.8



TEST NUMBER: P1215786  
 CATALOG NUMBER: 24-ID2-35-CFD1-L835-U

**CANDELA DISTRIBUTION (continued):**

	0°	22.5°	45°	67.5°	90°
112.5°	7.2	6.1	9.2	11.8	13.8
115°	6.1	5.1	7.7	10.2	12.3
117.5°	5.1	4.6	6.1	8.7	10.7
120°	4.6	3.6	5.1	7.7	9.2
122.5°	4.1	3.1	3.6	6.1	7.7
125°	3.6	2.6	2.6	5.1	6.6
127.5°	2.6	2.0	1.5	4.1	5.1
130°	2.6	1.5	1.0	3.1	4.1
132.5°	2.0	1.5	0.5	2.0	3.1
135°	1.5	1.0	0.5	1.5	2.0
137.5°	1.0	1.0	0.5	1.0	1.5
140°	1.0	0.5	0.5	0.5	1.0
142.5°	0.5	0.5	0.5	0.5	0.5
145°	0.5	0.5	0.5	0.5	0.5
147.5°	0.5	0.5	0.5	0.5	0.5
150°	0.5	0.5	0.5	0.5	0.5
152.5°	0.5	0.5	0.5	0.5	0.5
155°	0.5	0.5	0.5	0.5	0.5
157.5°	0.5	0.5	0.5	0.5	0.5
160°	1.0	0.5	0.5	0.5	0.5
162.5°	0.0	0.0	0.0	0.0	0.0
165°	0.0	0.0	0.0	0.0	0.0
167.5°	0.0	0.0	0.0	0.0	0.0
170°	0.0	0.0	0.0	0.0	0.0
172.5°	0.0	0.0	0.0	0.0	0.0
175°	0.0	0.0	0.0	0.0	0.0
177.5°	0.0	0.0	0.0	0.0	0.0
180°	0.0	0.0	0.0	0.0	0.0

TEST NUMBER: P1215786

CATALOG NUMBER: 24-ID2-35-CFD1-L835-U

**CIE UGR TABLE:**

Reflectances:											
Ceiling		0.7	0.7	0.5	0.5	0.3	0.7	0.7	0.5	0.5	0.3
Wall		0.5	0.3	0.5	0.3	0.3	0.5	0.3	0.5	0.3	0.3
Reference plane		0.2	0.2	0.2	0.2	0.2	0.2	0.2	0.2	0.2	0.2
Room dimensions		Viewed crosswise					Viewed endwise				
X=2H	Y=2H	13.01	14.59	13.40	14.94	15.29	13.04	14.62	13.43	14.97	15.32
	3H	14.69	16.12	15.09	16.48	16.87	14.80	16.23	15.20	16.59	16.98
	4H	15.29	16.64	15.71	17.02	17.43	15.47	16.82	15.89	17.20	17.61
	6H	15.72	16.97	16.15	17.36	17.79	15.99	17.24	16.42	17.63	18.06
	8H	15.84	17.04	16.29	17.46	17.89	16.17	17.37	16.62	17.78	18.22
	12H	15.93	17.07	16.38	17.48	17.94	16.32	17.47	16.78	17.88	18.34
4H	2H	13.60	14.95	14.03	15.33	15.74	13.63	14.98	14.05	15.36	15.77
	3H	15.50	16.64	15.94	17.06	17.50	15.61	16.74	16.04	17.17	17.60
	4H	16.23	17.26	16.69	17.70	18.17	16.41	17.43	16.86	17.88	18.35
	6H	16.78	17.68	17.26	18.15	18.64	17.06	17.95	17.54	18.42	18.91
	8H	16.95	17.79	17.44	18.26	18.76	17.30	18.14	17.78	18.61	19.11
	12H	17.07	17.83	17.58	18.33	18.83	17.51	18.26	18.01	18.76	19.27
8H	4H	16.53	17.37	17.02	17.84	18.34	16.69	17.53	17.17	18.00	18.50
	6H	17.20	17.90	17.72	18.41	18.92	17.46	18.16	17.98	18.68	19.19
	8H	17.44	18.07	17.97	18.60	19.12	17.78	18.41	18.32	18.94	19.46
	12H	17.64	18.19	18.16	18.71	19.30	18.09	18.64	18.62	19.16	19.75
12H	4H	16.57	17.32	17.07	17.83	18.33	16.72	17.47	17.22	17.97	18.48
	6H	17.26	17.89	17.79	18.42	18.94	17.51	18.14	18.04	18.67	19.19
	8H	17.56	18.12	18.09	18.63	19.22	17.89	18.45	18.42	18.96	19.56



Cooper Lighting Solutions Photometric Lab  
1121 Highway 74 South  
Peachtree City, GA 30269



LM-79-2019: Approved Method: Electrical and Photometric Measurements of Solid-State Lighting Products

Report Prepared for

Cooper Lighting Solutions

Corelite

Report Number: SP1-2506-458-1

Test Date: 07/23/2025

Luminaire Tested: 22ID2-55-CFR1-L835-U

Data in this report applies to families of products including 22ID2-55-CFR1-L835-U

**Test Information**

Test Method: LM-79-2019  
 Report Number: SP1-2506-458-1  
 Test Lab: COOPER LIGHTING SOLUTIONS  
 Photometer: SP1 - 76IN SPHERE  
 Measurement Geometry: 4π  
 Issue Date: 08/27/2025  
 Manufacturer: COOPER LIGHTING SOLUTIONS  
 Product Line: Corelite  
 Catalog Number: **22ID2-55-CFR1-L835-U**  
 Description: 2X2 CGTX WITH INDEPTH FRAME AND CFR1 LENS - 5500 LUMEN 3500K 80CRI

**Spectral Parameters**

CCT (K): 3440  
 CIE u': 0.2370  
 CIE v': 0.5132  
 Duv: 0.0005  
 CIE x: 0.4093  
 CIE y: 0.3940  
 CIE z: 0.1967  
 Peak Wavelength (nm): 599  
 Dominant Wavelength (nm): 580  
 Purity: 41.09375  
 Rf: 84.9  
 Rg: 94.6

CRI (Ra):	84.2		
R1:	82.8	R9:	13.6
R2:	91.7	R10:	80.1
R3:	96.7	R11:	81.1
R4:	81.9	R12:	65.8
R5:	82.6	R13:	85.2
R6:	88.8	R14:	98.7
R7:	85.0	R15:	76.2
R8:	63.7		

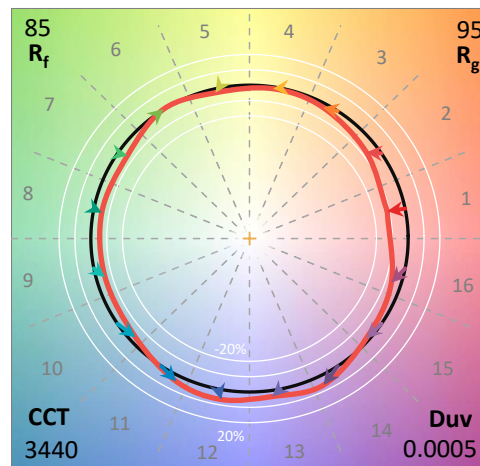

**Test Conditions**

Stabilization Time: 36M  
 Operation Time: 1H 36M  
 Sphere Temperature (°C): 24.0

REPORT NUMBER: SP1-2506-458-1

Measurement and Test Equipment			
Instrument	Identification Number	Calibration Date	Calibration Due Date
Photometer	76INCH SPHERE IN0058	6/16/2025	12/16/2025
Power Meter	XITRON INXT2011004	1/21/2025	1/21/2026
AC Power Source	CHROMA 61603 IN0063	10/22/2024	10/22/2025
DC Power Source	AGILENT E3634A IN0208	10/22/2024	10/22/2025
Sphere Thermometer	ONSET IN0085	10/22/2024	10/22/2025
Room Thermometer	ONSET IN0046	10/22/2024	10/22/2025

REPORT NUMBER: SP1-2506-458-1

CIE 1931 Chromaticity Diagram

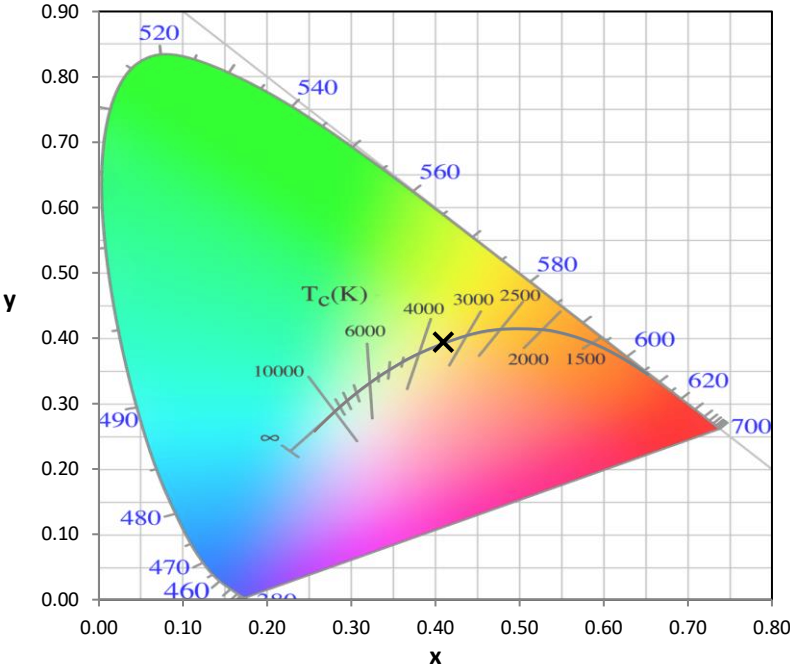

CIE 1931 Chromaticity Diagram with 2017 ANSI 7-Step and 4-Step Quadrangles

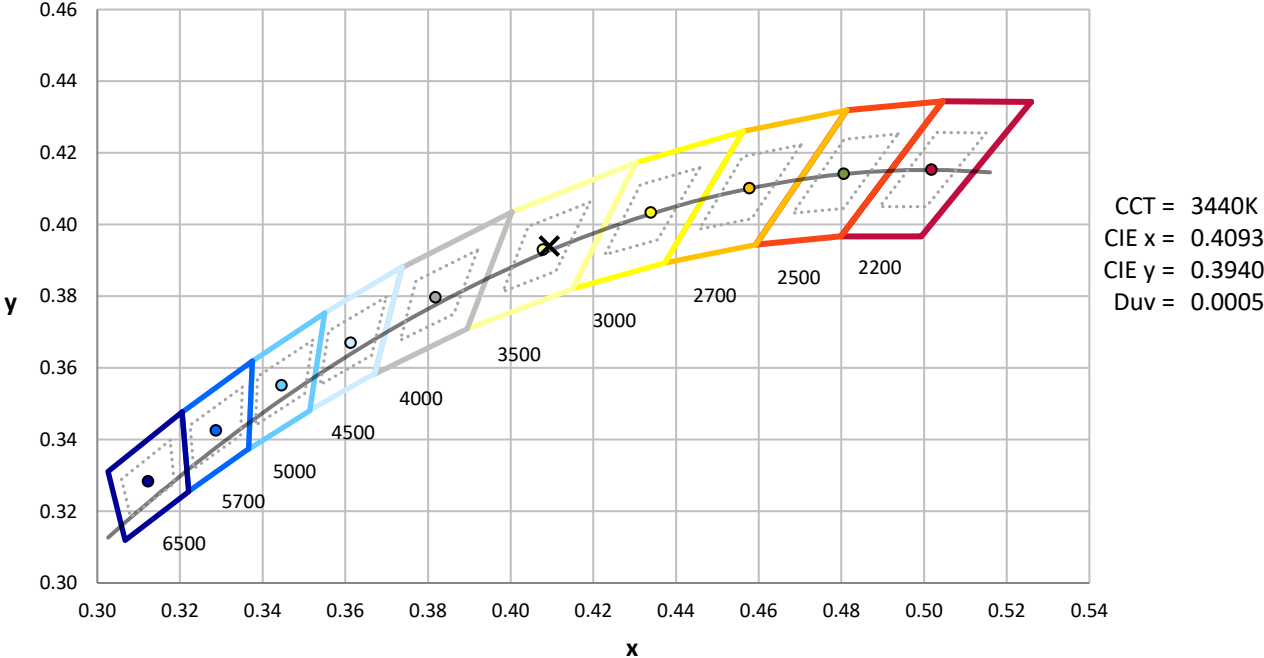

Point lies inside the ANSI 3500K 4-step quadrangle

REPORT NUMBER: SP1-2506-458-1

**Photopic Flux vs. Wavelength**

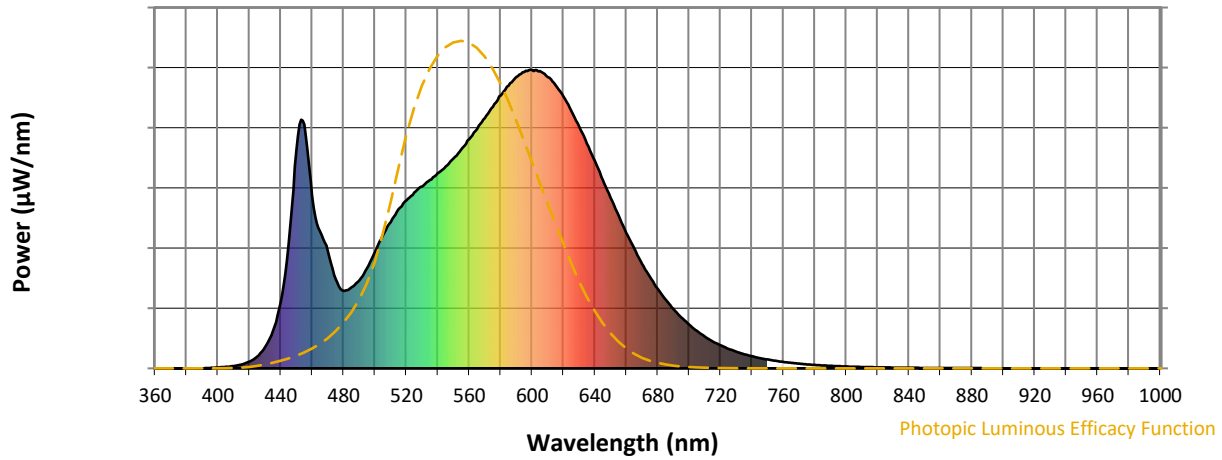

**Photopic Lumens: NR**

$\lambda$ (nm)	Power W <sup>^</sup> /nm	Lumens ( $\phi$ /nm)	$\lambda$ (nm)	Power W <sup>^</sup> /nm	Lumens ( $\phi$ /nm)	$\lambda$ (nm)	Power W <sup>^</sup> /nm	Lumens ( $\phi$ /nm)	$\lambda$ (nm)	Power W <sup>^</sup> /nm	Lumens ( $\phi$ /nm)	$\lambda$ (nm)	Power W <sup>^</sup> /nm	Lumens ( $\phi$ /nm)
360	0	NR	490	295	NR	620	910	NR	750	30	NR	880	1	NR
365	0	NR	495	335	NR	625	862	NR	755	25	NR	885	1	NR
370	0	NR	500	390	NR	630	809	NR	760	21	NR	890	1	NR
375	0	NR	505	445	NR	635	752	NR	765	18	NR	895	0	NR
380	0	NR	510	490	NR	640	694	NR	770	16	NR	900	0	NR
385	0	NR	515	532	NR	645	630	NR	775	13	NR	905	0	NR
390	0	NR	520	563	NR	650	571	NR	780	12	NR	910	0	NR
395	2	NR	525	588	NR	655	512	NR	785	10	NR	915	0	NR
400	3	NR	530	609	NR	660	453	NR	790	8	NR	920	0	NR
405	5	NR	535	631	NR	665	401	NR	795	7	NR	925	0	NR
410	8	NR	540	654	NR	670	351	NR	800	6	NR	930	0	NR
415	13	NR	545	677	NR	675	306	NR	805	5	NR	935	0	NR
420	23	NR	550	702	NR	680	267	NR	810	5	NR	940	0	NR
425	40	NR	555	734	NR	685	230	NR	815	4	NR	945	0	NR
430	70	NR	560	767	NR	690	199	NR	820	4	NR	950	0	NR
435	126	NR	565	802	NR	695	171	NR	825	3	NR	955	0	NR
440	221	NR	570	838	NR	700	146	NR	830	3	NR	960	0	NR
445	418	NR	575	875	NR	705	125	NR	835	2	NR	965	0	NR
450	729	NR	580	913	NR	710	107	NR	840	2	NR	970	0	NR
455	816	NR	585	946	NR	715	90	NR	845	2	NR	975	0	NR
460	578	NR	590	976	NR	720	77	NR	850	1	NR	980	0	NR
465	458	NR	595	992	NR	725	66	NR	855	1	NR	985	0	NR
470	390	NR	600	999	NR	730	56	NR	860	1	NR	990	0	NR
475	299	NR	605	995	NR	735	47	NR	865	1	NR	995	0	NR
480	260	NR	610	975	NR	740	40	NR	870	1	NR	1000	0	NR
485	271	NR	615	948	NR	745	34	NR	875	1	NR			

REPORT NUMBER: SP1-2506-458-1

**Scotopic Flux vs. Wavelength**

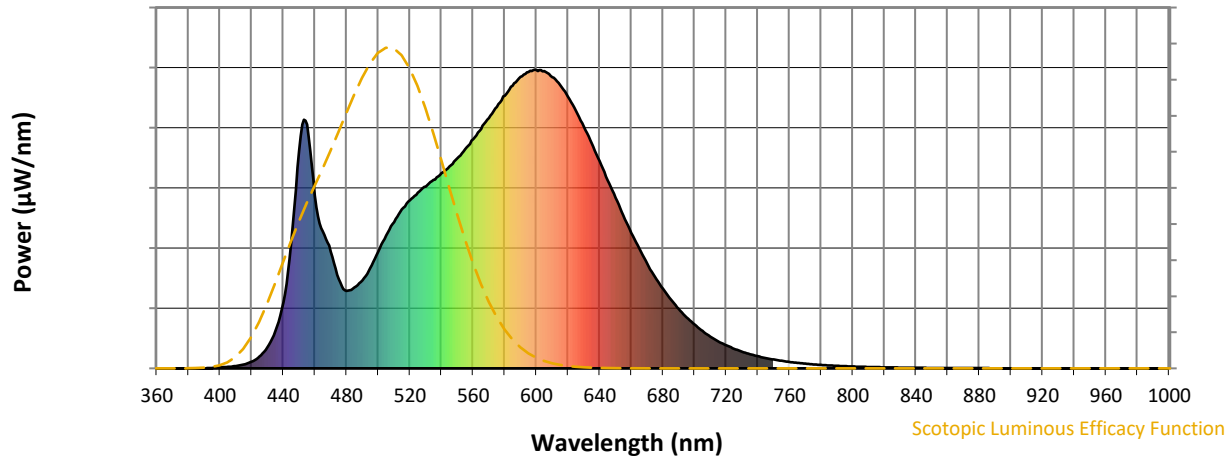

**Scotopic Lumens: NR**

**S/P: 1.53**

$\lambda$ (nm)	Power W <sup>^</sup> /nm	Lumens ( $\phi$ /nm)	$\lambda$ (nm)	Power W <sup>^</sup> /nm	Lumens ( $\phi$ /nm)	$\lambda$ (nm)	Power W <sup>^</sup> /nm	Lumens ( $\phi$ /nm)	$\lambda$ (nm)	Power W <sup>^</sup> /nm	Lumens ( $\phi$ /nm)	$\lambda$ (nm)	Power W <sup>^</sup> /nm	Lumens ( $\phi$ /nm)
360	0	NR	490	295	NR	620	910	NR	750	30	NR	880	1	NR
365	0	NR	495	335	NR	625	862	NR	755	25	NR	885	1	NR
370	0	NR	500	390	NR	630	809	NR	760	21	NR	890	1	NR
375	0	NR	505	445	NR	635	752	NR	765	18	NR	895	0	NR
380	0	NR	510	490	NR	640	694	NR	770	16	NR	900	0	NR
385	0	NR	515	532	NR	645	630	NR	775	13	NR	905	0	NR
390	0	NR	520	563	NR	650	571	NR	780	12	NR	910	0	NR
395	2	NR	525	588	NR	655	512	NR	785	10	NR	915	0	NR
400	3	NR	530	609	NR	660	453	NR	790	8	NR	920	0	NR
405	5	NR	535	631	NR	665	401	NR	795	7	NR	925	0	NR
410	8	NR	540	654	NR	670	351	NR	800	6	NR	930	0	NR
415	13	NR	545	677	NR	675	306	NR	805	5	NR	935	0	NR
420	23	NR	550	702	NR	680	267	NR	810	5	NR	940	0	NR
425	40	NR	555	734	NR	685	230	NR	815	4	NR	945	0	NR
430	70	NR	560	767	NR	690	199	NR	820	4	NR	950	0	NR
435	126	NR	565	802	NR	695	171	NR	825	3	NR	955	0	NR
440	221	NR	570	838	NR	700	146	NR	830	3	NR	960	0	NR
445	418	NR	575	875	NR	705	125	NR	835	2	NR	965	0	NR
450	729	NR	580	913	NR	710	107	NR	840	2	NR	970	0	NR
455	816	NR	585	946	NR	715	90	NR	845	2	NR	975	0	NR
460	578	NR	590	976	NR	720	77	NR	850	1	NR	980	0	NR
465	458	NR	595	992	NR	725	66	NR	855	1	NR	985	0	NR
470	390	NR	600	999	NR	730	56	NR	860	1	NR	990	0	NR
475	299	NR	605	995	NR	735	47	NR	865	1	NR	995	0	NR
480	260	NR	610	975	NR	740	40	NR	870	1	NR	1000	0	NR
485	271	NR	615	948	NR	745	34	NR	875	1	NR			

REPORT NUMBER: SP1-2506-458-1

**Melanopic Flux vs. Wavelength**

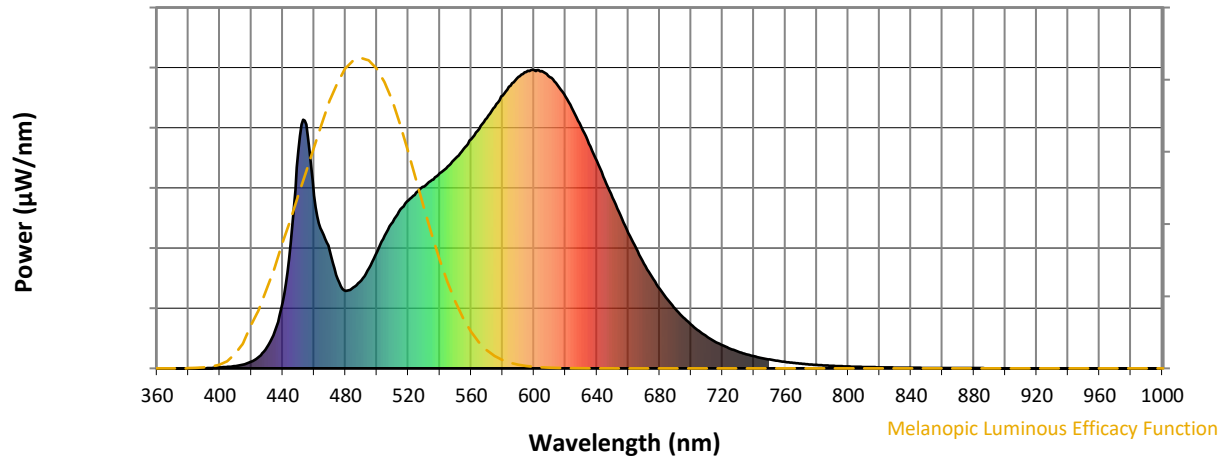

**Melanopic Lumens: NR**

**M/P: 3.07**

λ (nm)	Power W <sup>^</sup> /nm	Lumens (φ/nm)	λ (nm)	Power W <sup>^</sup> /nm	Lumens (φ/nm)	λ (nm)	Power W <sup>^</sup> /nm	Lumens (φ/nm)	λ (nm)	Power W <sup>^</sup> /nm	Lumens (φ/nm)	λ (nm)	Power W <sup>^</sup> /nm	Lumens (φ/nm)
360	0	NR	490	295	NR	620	910	NR	750	30	NR	880	1	NR
365	0	NR	495	335	NR	625	862	NR	755	25	NR	885	1	NR
370	0	NR	500	390	NR	630	809	NR	760	21	NR	890	1	NR
375	0	NR	505	445	NR	635	752	NR	765	18	NR	895	0	NR
380	0	NR	510	490	NR	640	694	NR	770	16	NR	900	0	NR
385	0	NR	515	532	NR	645	630	NR	775	13	NR	905	0	NR
390	0	NR	520	563	NR	650	571	NR	780	12	NR	910	0	NR
395	2	NR	525	588	NR	655	512	NR	785	10	NR	915	0	NR
400	3	NR	530	609	NR	660	453	NR	790	8	NR	920	0	NR
405	5	NR	535	631	NR	665	401	NR	795	7	NR	925	0	NR
410	8	NR	540	654	NR	670	351	NR	800	6	NR	930	0	NR
415	13	NR	545	677	NR	675	306	NR	805	5	NR	935	0	NR
420	23	NR	550	702	NR	680	267	NR	810	5	NR	940	0	NR
425	40	NR	555	734	NR	685	230	NR	815	4	NR	945	0	NR
430	70	NR	560	767	NR	690	199	NR	820	4	NR	950	0	NR
435	126	NR	565	802	NR	695	171	NR	825	3	NR	955	0	NR
440	221	NR	570	838	NR	700	146	NR	830	3	NR	960	0	NR
445	418	NR	575	875	NR	705	125	NR	835	2	NR	965	0	NR
450	729	NR	580	913	NR	710	107	NR	840	2	NR	970	0	NR
455	816	NR	585	946	NR	715	90	NR	845	2	NR	975	0	NR
460	578	NR	590	976	NR	720	77	NR	850	1	NR	980	0	NR
465	458	NR	595	992	NR	725	66	NR	855	1	NR	985	0	NR
470	390	NR	600	999	NR	730	56	NR	860	1	NR	990	0	NR
475	299	NR	605	995	NR	735	47	NR	865	1	NR	995	0	NR
480	260	NR	610	975	NR	740	40	NR	870	1	NR	1000	0	NR
485	271	NR	615	948	NR	745	34	NR	875	1	NR			

**Summary**

$R_f = 84.9$   
 $R_g = 94.6$   
 $CIE R_a = 84.2$   
 $R_9 = 13.6$

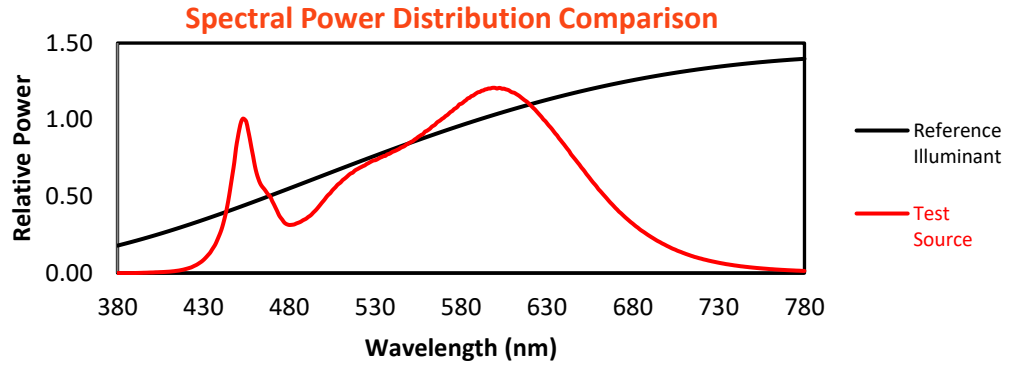

**Color Vector Graphics**

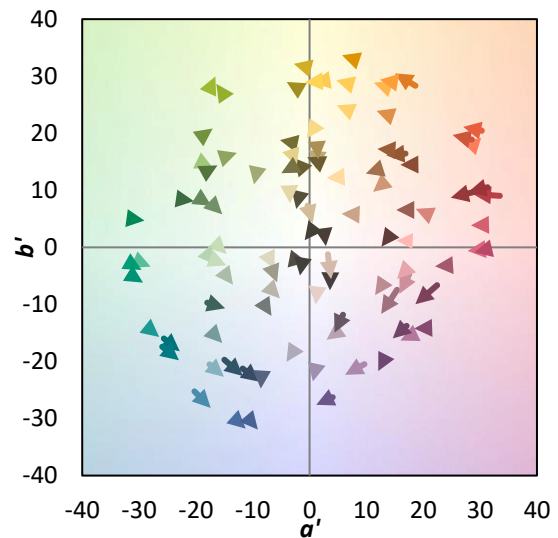
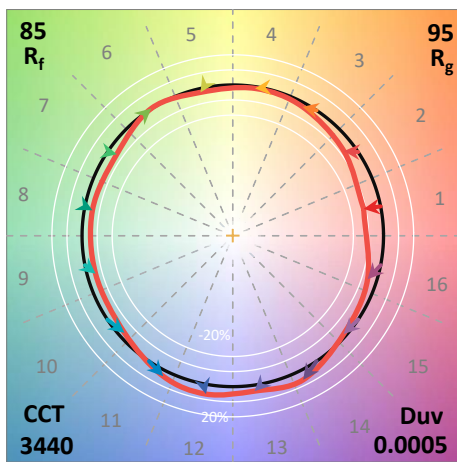
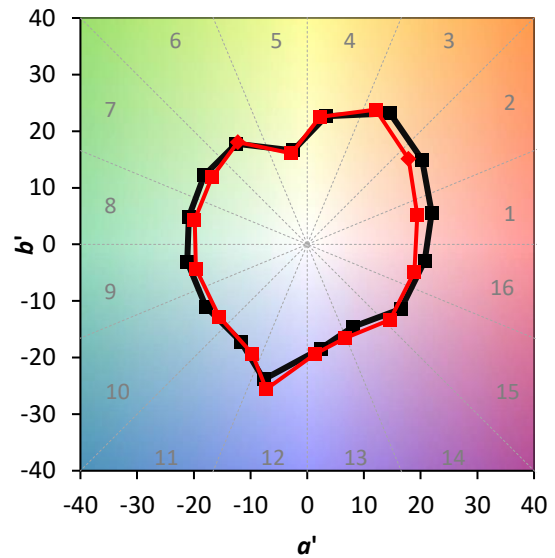
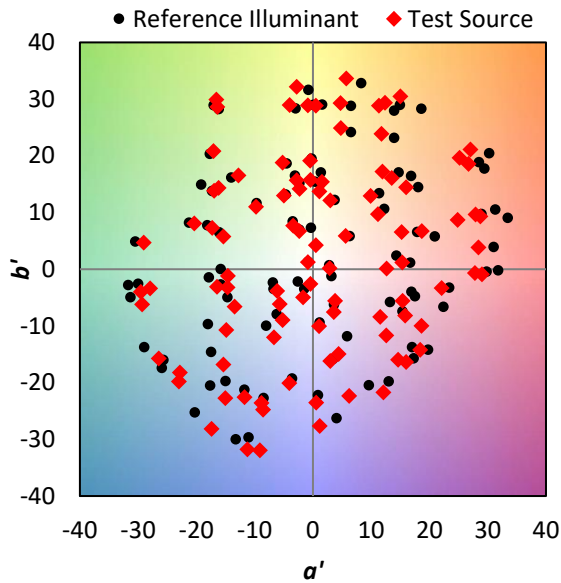



Individual Sample Fidelity Index ( $R_{f,i}$ )

CES01 = 86	CES26 = 87	CES51 = 92	CES76 = 81
CES02 = 62	CES27 = 91	CES52 = 93	CES77 = 85
CES03 = 31	CES28 = 94	CES53 = 90	CES78 = 80
CES04 = 70	CES29 = 92	CES54 = 89	CES79 = 92
CES05 = 49	CES30 = 89	CES55 = 86	CES80 = 90
CES06 = 51	CES31 = 94	CES56 = 85	CES81 = 77
CES07 = 41	CES32 = 86	CES57 = 83	CES82 = 96
CES08 = 40	CES33 = 97	CES58 = 84	CES83 = 96
CES09 = 29	CES34 = 91	CES59 = 91	CES84 = 91
CES10 = 75	CES35 = 95	CES60 = 89	CES85 = 76
CES11 = 58	CES36 = 79	CES61 = 87	CES86 = 73
CES12 = 64	CES37 = 95	CES62 = 81	CES87 = 85
CES13 = 43	CES38 = 84	CES63 = 85	CES88 = 89
CES14 = 74	CES39 = 98	CES64 = 78	CES89 = 78
CES15 = 71	CES40 = 97	CES65 = 78	CES90 = 90
CES16 = 47	CES41 = 95	CES66 = 75	CES91 = 71
CES17 = 50	CES42 = 96	CES67 = 74	CES92 = 65
CES18 = 56	CES43 = 92	CES68 = 79	CES93 = 79
CES19 = 72	CES44 = 99	CES69 = 83	CES94 = 64
CES20 = 66	CES45 = 95	CES70 = 77	CES95 = 74
CES21 = 86	CES46 = 91	CES71 = 71	CES96 = 85
CES22 = 78	CES47 = 94	CES72 = 90	CES97 = 90
CES23 = 92	CES48 = 83	CES73 = 72	CES98 = 86
CES24 = 90	CES49 = 92	CES74 = 90	CES99 = 79
CES25 = 72	CES50 = 93	CES75 = 75	

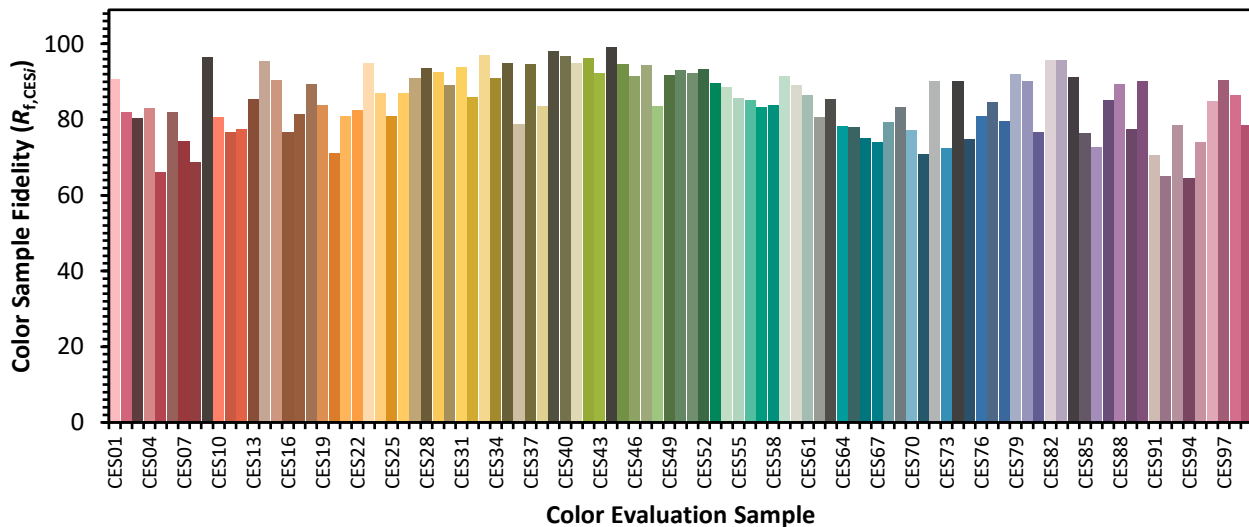

Color Rendition by Hue-Angle Bin

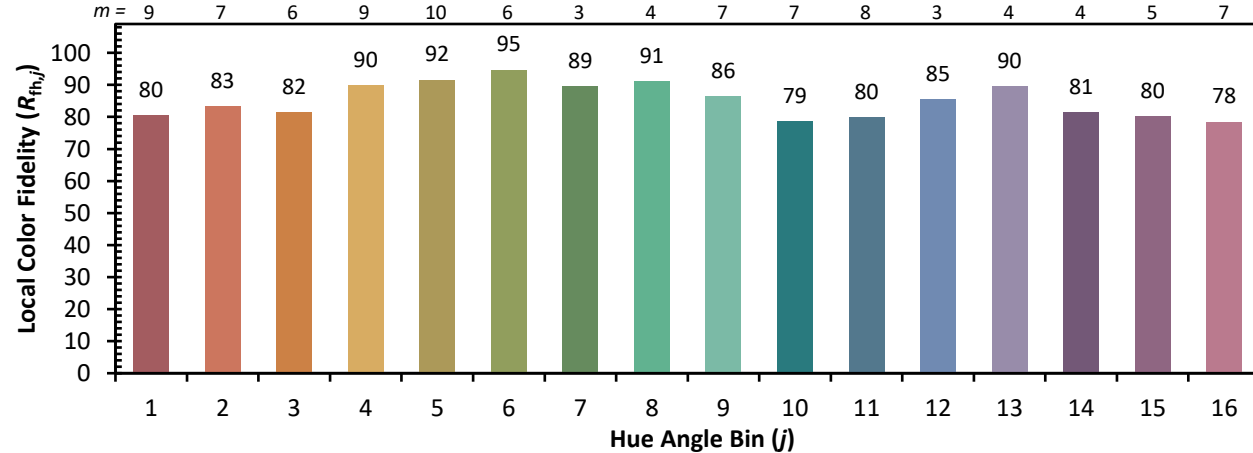
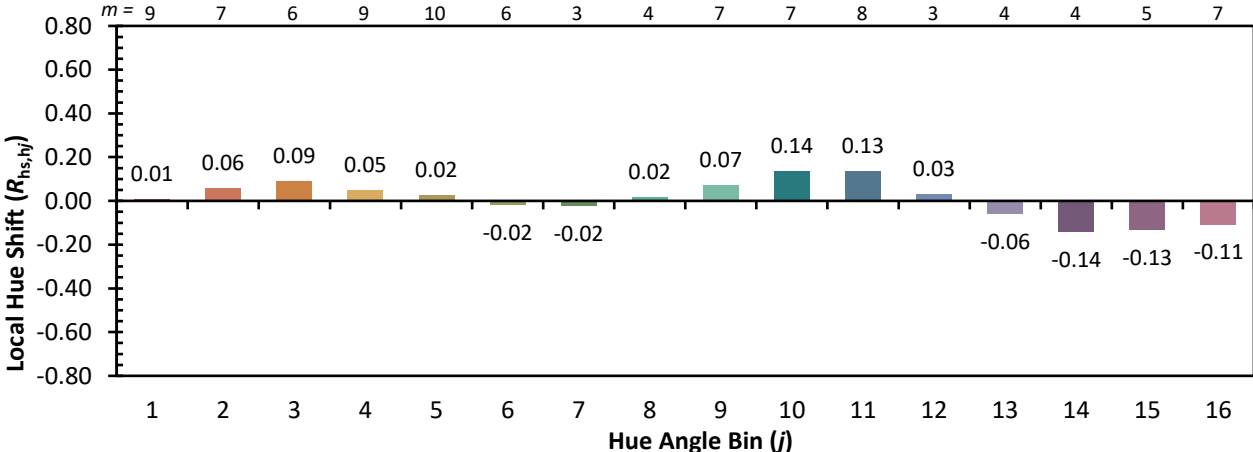
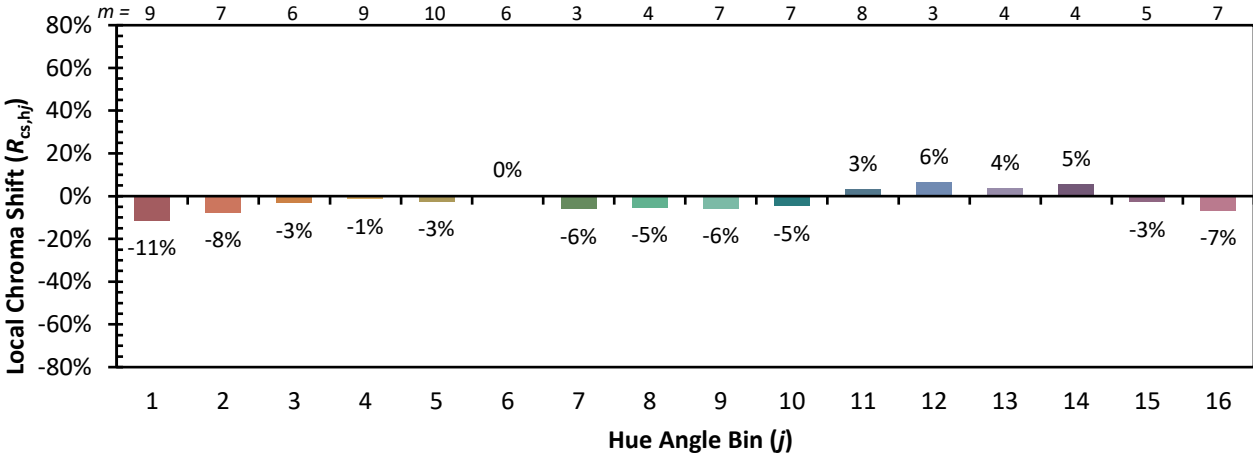

Measure Comparisons

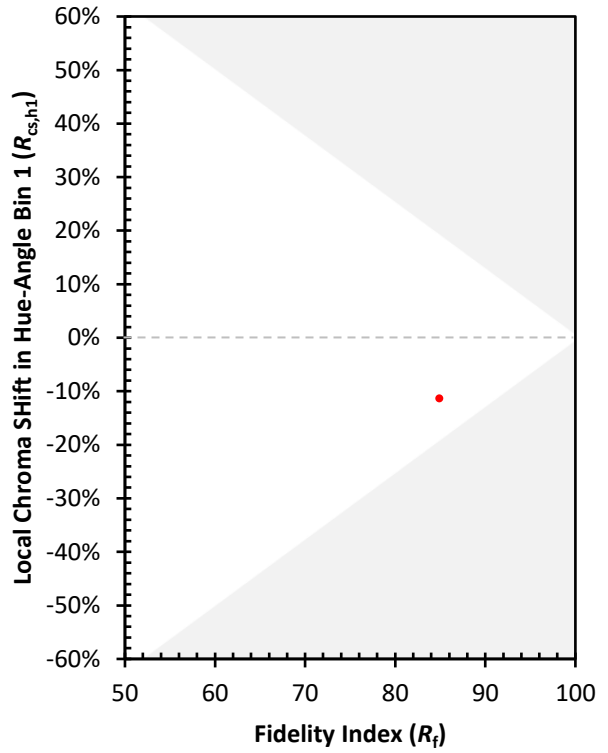
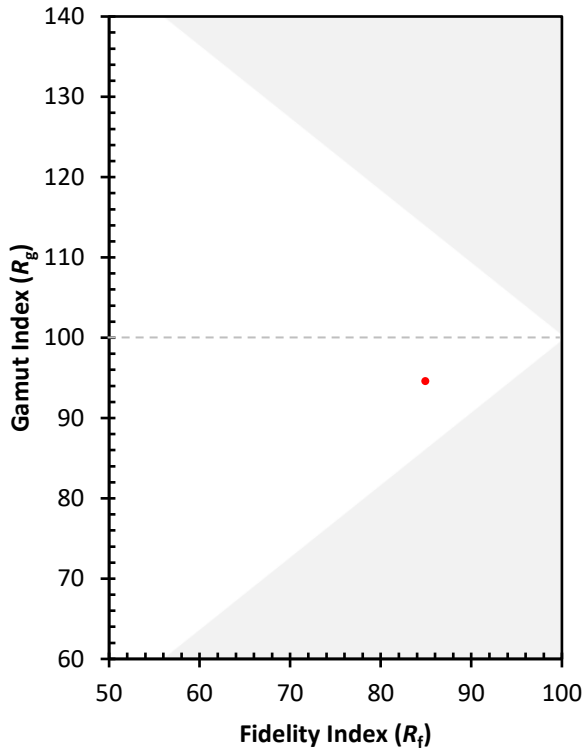

(END OF REPORT)